

Cervoz Industrial Embedded Module

M.2 2280

Momentum Series (MLC)

M336 Family

Product Datasheet



Date: 2018.04.20

Revision: 1.0

File: Cervoz_Industrial_Embedded_Module_M.2_2280_M336_Datasheet_Rev1.0



Revision History

Date	Revision	Description
2018.04.20	1.0	First Released



Table of Contents

- 1. Product Overview.....4**
 - 1.1 Introduction.....4
 - 1.2 Feature.....4
 - 1.3 Product Appearance & Models.....5
- 2. Product Specifications.....6**
 - 2.1 General Specifications.....6
 - 2.2 Performance.....7
 - 2.3 Drive Capacity.....7
 - 2.4 Electronic Specifications.....7
 - 2.4.1 Block Diagram.....7
 - 2.4.2 Pin Assignment.....8-9
 - 2.5 Environmental Specifications.....10
 - 2.6 Mechanical Specifications.....10
- 3. Supported Command.....11**
 - 3.1 List of Command Sets.....11~12
- 4. Part No. Decoder.....13**
 - 4.1 Part No. Decoder.....13~14

1. Product Overview

1.1 Introduction

Cervoz Industrial M.2 2280 Embedded Module M336 family is a Solid State Flash Disk product that is in compliance with the M.2 and SATA III standards. M.2 2280 M336 family fits in any M.2 2280 sockets in a PC or motherboard; it can be used for both booting and storage purposes. In addition, M336 family has a very unique function named Powerguard. The purpose of Powerguard is to protect data loss while encountering an improper power failure. Powerguard would complete the task of saving the boot files from the controller into the flash storage after sudden power loss. Cervoz designs these flash modules with additional tantalum capacitors to store these extra charges. With this special design, M.2 2280 is constantly charging the tantalum capacitors with 12V power during its operation.

M350 family uses superior quality preselected multi-level cell (MLC) NAND flash memory from the industry leading manufacturer Toshiba. This product includes both standard temperature range and wide temperature range options with various capacities to choose from.

1.2 Feature

- Compliant with SATA III 6.0Gb/s
- MLC NAND flash memory
- Capacity: 32GB ~ 256GB
- Operating as boot disk
- Product includes Standard Temperature range & Wide Temperature range
- Static and dynamic wear leveling
- Bad block management
- S.M.A.R.T. & TRIM command

1.3 Product Appearance & Models

Cervoz Industrial M.2 2280 Module M336



M336 Family Standard Temp. (0°C ~ 70°C) Model No.	M336 Family Wide Temp. (-40°C ~ 85°C) Model No.	Capacity
CIE-M8M336TKD032GS	CIE-M8M336TKD032GW	32GB
CIE-M8M336TKD064GS	CIE-M8M336TKD064GW	64GB
CIE-M8M336TLD128GS	CIE-M8M336TLD128GW	128GB
CIE-M8M336TMD256GS	CIE-M8M336TMD256GW	256GB

Please Note:

Since certain storage capacity has to be reserved for firmware and controller management purposes; the physical capacity of the SATA flash module will be approximately 90% of the indicated capacity. If you need to install an image that has the exact (or close to) the indicated size of the flash module, please choose your flash module with a greater capacity.

2. Product Specifications

2.1 General Specifications

Form Factor	M.2 2280
Interface	SATA III 6.0Gb/s (backward compatible to 3.0Gb/s, 1.5Gb/s)
Connector	M.2
NAND Flash Type	MLC
Capacity	32GB/64GB/128GB/256GB
Sequential Read	up to 520MB/s
Sequential Write	up to 355MB/s
ECC Scheme	up to 66bits / 1K Byte
MTBF	2,000,000 hours
TeraByte Written (TBW)	32GB : 31 64GB : 63 128GB : 125 256GB : 250
Low Power Management	DIPM/HIPM mode
Supply Voltage	+3.3V DC +/-5%
Power Consumption	Active mode: < 2310mW Idle mode: < 380mW
Dimension (LxWxH)	80.00*22.00*3.90mm

2.2 Performance

The performance was measured with below PC configuration:

- Platform: ASUS Z97-A (Intel Z97)
- RAM: Cervoz CIR-S3DUSK1604G(DDR3 4G 1600MHz)
- Operation Systems: Windows 7
- Testing Utility: Crystal Disk Mark v5.1.0 X64
- SATAIII port (6.0 Gb/s) performance

Capacity	32GB	64GB	128GB	256GB
Sequential Read (max.)	265MB/s	520MB/s	505MB/s	520MB/s
Sequential Write (max.)	45MB/s	90MB/s	175MB/s	355MB/s
4KB Random Read (QD32)	105MB/s	205MB/s	295MB/s	305MB/s
4KB Random Write (QD32)	45MB/s	85MB/s	175MB/s	315MB/s

Actual performance may vary depending on use conditions and environment

2.3 Drive Capacity

Capacity	Cylinders	Heads	Sectors	Max LBA
32GB	16,383	15	63	61,865,984
64GB	16,383	15	63	123,731,968
128GB	16,383	15	63	247,463,936
226GB	16,383	15	63	494,927,872

2.4 Electronic Specifications

2.4.1 Block Diagram

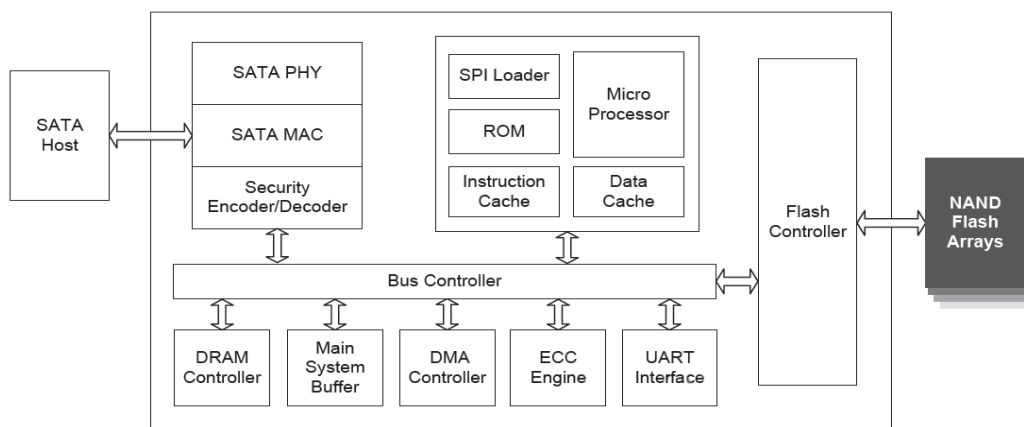

2.4.2 Pin Assignment

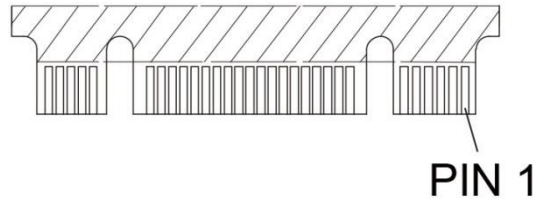

Pin #	Pin Description	Signal Name	Pin #	Pin Description	Signal Name
1	Ground	CONFIG_3 = GND	12	Module Key	Key
2	3.3V power in	+3.3V	13	Module Key	Key
3	Ground	GND	14	Module Key	Key
4	3.3V power in	+3.3V	15	Module Key	Key
5	Not Used	NC	16	Module Key	Key
6	Not Used	NC	17	Module Key	Key
7	Not Used	NC	18	Module Key	Key
8	Not Used	NC	19	Module Key	Key
9	Not Used or Ground	NC or GND ^{Note}	20	Not Used	NC
10	LED/DAS/DSS	DAS/DSS# (O) (OD)	21	Ground	CONFIG_0 = GND
11	Not Used	NC	22	Not Used	NC
Pin #	Pin Description	Signal Name	Pin #	Pin Description	Signal Name
23	Not Used	NC	50	Not Used	NC
24	Not Used	NC	51	Ground	GND
25	Not Used	NC	52	Not Used	NC
26	Not Used	NC	53	Not Used	NC
27	Ground	GND	54	Not Used	NC
28	Not Used	NC	55	Not Used	NC
29	Not Used	NC	56	MFG Data	NC
30	Not Used	NC	57	Ground	GND
31	Not Used	NC	58	MFG Clock	NC
32	Not Used	NC	59	Module Key	Key
33	Ground	GND	60	Module Key	Key
34	Not Used	NC	61	Module Key	Key
35	Not Used	NC	62	Module Key	Key
36	Not Used	NC	63	Module Key	Key
37	Not Used	NC	64	Module Key	Key
38	Enter/Exit Device Sleep	DEVSLP (I) (0/3.3V)	65	Module Key	Key

39	Ground	GND	66	Module Key	Key
40	Not Used	NC	67	Not Used	NC
41	SATA Txp	+B – TX+	68	32kHz clock supply	SUSCLK (I) (0/3.3V)
42	Not Used	NC	69	Defines module type	CONFIG_1 = GND
43	SATA Txn	-B – TX-	70	3.3V power in	+3.3V
44	Not Used	NC	71	Ground	GND
45	Ground	GND	72	3.3V power in	+3.3V
46	Not Used	NC	73	Ground	GND
47	SATA Rxn	-A – RX-	74	3.3V power in	+3.3V
48	Not Used	NC	75	Ground	CONFIG_2 = GND
49	SATA Rxp	+A – RX+			

Note: NC for Socket 2, and GND for Socket 3.

2.5 Environmental Specifications

Type		Value
Temperature	Standard Temperature Operating:	0°C~70°C
	Standard Temperature Storage:	-40°C~85°C
	Wide Temperature Operating:	-40°C~85°C
	Wide Temperature Storage:	-50°C~95°C
Humidity	Operating & Storage	10~95%, Non-Condensing
Vibration	Non-Operating	20G, 10Hz~2000Hz
Shock	Non-Operating	1500G, 0.5ms

2.6 Mechanical Specifications

Type	Value
Form Factor	M.2 2280
Length	80.00mm +/-0.15mm
Width	22.00mm +/-0.15mm
Thickness	3.90mm +/-0.08mm

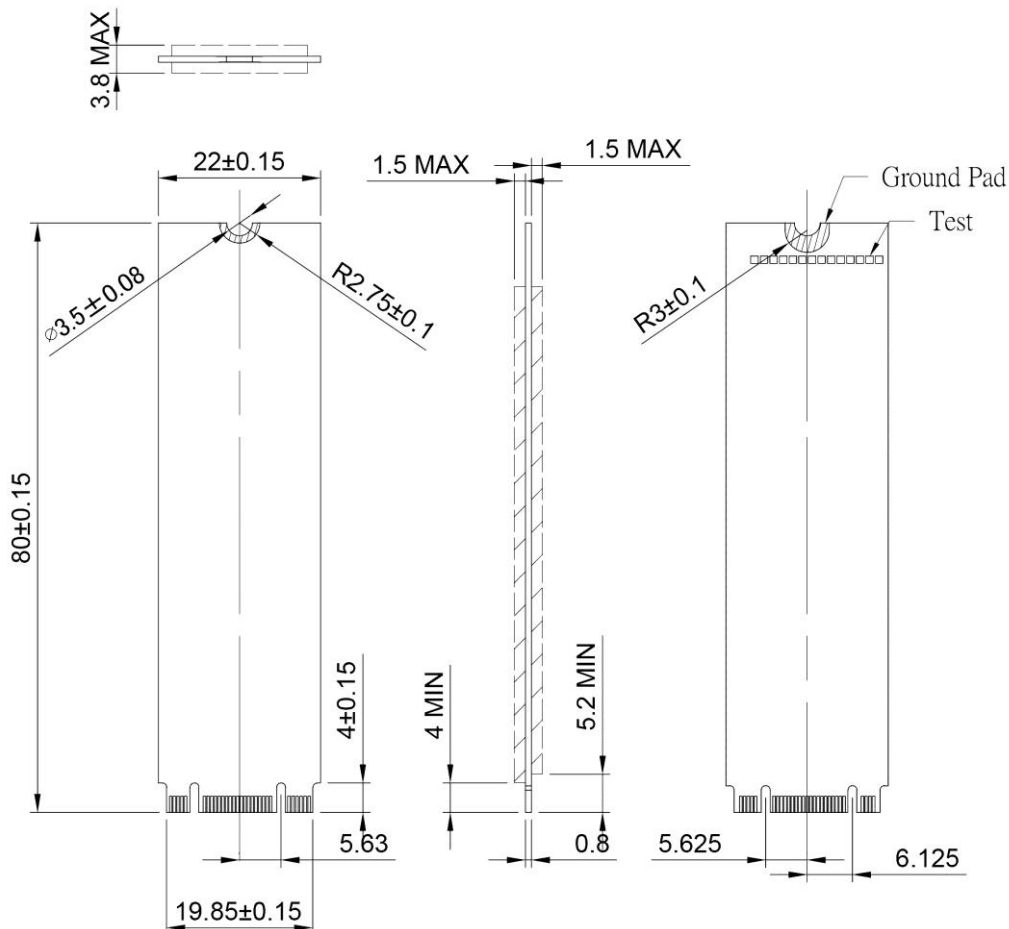

3. Supported Command

3.1 List of Command Sets

Command	Code	Protocol
General Feature Set		
Execute Device Diagnostic	90h	Execute device diagnostic
Download Microcode	92h	PIO data-out
Download Microcode DMA	93h	DMA
Flush Cache	E7h	Non-data
Identify Device	ECh	PIO data-in
Initialize Drive Parameters	91h	Non-data
NOP	00h	Non-data
Read Buffer	E4h	PIO data-in
Read Buffer DMA	E9h	DMA
Read DMA	C8h or C9h	DMA
Read Log Ext	2Fh	PIO data-in
Read Log DMA Ext	47h	DMA
Read Multiple	C4h	PIO data-in
Read Sector(s)	20h or 21h	PIO data-in
Read Verify Sector(s)	40h or 41h	Non-data
Set Feature	EFh	Non-data
Set Multiple Mode	C6h	Non-data
Write Buffer	E8h	PIO data-out
Write Buffer DMA	EBh	DMA
Write DMA	CAh or CBh	DMA
Write Log Ext	3Fh	PIO data-out
Write Log DMA Ext	57h	DMA
Write Multiple	C5h	PIO data-out
Write Sector(s)	30h	PIO data-out

Command	Code	Protocol
Power Management Feature Set		
Check Power Mode	E5h or 98h	Non-data
Idle	E3h or 97h	Non-data
Idle Immediate	E1h or 95h	Non-data
Sleep	E6h or 99h	Non-data
Standby	E2h or 96h	Non-data
Standby Immediate	E0h or 94h	Non-data
Security Mode Feature Set		
Security Set Password	F1h	PIO data-out
Security Unlock	F2h	PIO data-out
Security Erase Prepare	F3h	Non-data
Security Erase Unit	F4h	PIO data-out
Security Freeze Lock	F5h	Non-data
Security Disable Password	F6h	PIO data-out
SMART Feature Set		
SMART Disable Operations	B0h	Non-data
SMART Enable/Disable Autosave	B0h	Non-data
SMART Enable Operations	B0h	Non-data
SMART Execute OFF-LINE Immediate	B0h	Non-data
SMART Read Log	B0h	PIO data-in
SMART Read Data	B0h	PIO data-in
SMART Read Threshold	B0h	PIO data-in
SMART Return Status	B0h	Non-data
SMART Save Attribute Values	B0h	Non-data
SMART Write Log	B0h	PIO data-out
Host Protected Area Feature Set		
Read Native Max Address	F8h	Non-data
Set Max Address	F9h	Non-data
Set Max Set Password	F9h	PIO data-out
Set Max Lock	F9h	Non-data
Set Max Freeze Lock	F9h	Non-data
Set Max Unlock	F9h	PIO data-out

Command	Code	Protocol
48-bit Address Feature Set		
Flush Cache Ext	EAh	Non-data
Read Sector(s) Ext	24h	PIO data-in
Read DMA Ext	25h	DMA
Read Multiple Ext	29h	PIO data-in
Read Native Max Address Ext	27h	Non-data
Read Verify Sector(s) Ext	42h	Non-data
Set Max Address Ext	37h	Non-data
Write DMA Ext	35h	DMA
Write DMA FUA Ext	3Dh	DMA
Write Multiple Ext	39h	PIO data-out
Write Multiple FUA Ext	CEh	PIO data-out
Write Sector(s) Ext	34h	PIO data-out
NCQ Feature Set		
Read FPDMA Queued	60h	DMA Queued
Write FPDMA Queued	61h	DMA Queued
DCO Feature Set		
Device Configuration	B1h	/
Sanitize Device Feature Set		
Sanitize Device	B4h	/
Miscellaneous and Historical Commands		
Data Set Management	06h	DMA
Seek	70h	Non-data
Recalibrate	10h	Non-data
Write Verify	3Ch	PIO data-out
Write Uncorrectable Ext	45h	Non-data

4. Part No. Decoder

4.1 Part No. Decoder

1	-	2	3	4	5	6	7	8	9
Product Line	-	Form Factor	Product Series	Cervoz Family Code (Bus / Internal Control)	Flash Brand	Flash Capacity	Flash Mode	Module Capacity	Operating Temp.
XXX	-	XX	X	XXX	X	X	X	XXXX	X

1. Product Line

CIS	Cervoz Industrial SSD
CIM	Cervoz Industrial Memory Card
CIE	Cervoz Industrial Embedded Module

2. Form Factor

2S	2.5" SATA
2P	2.5" PATA
CF	CompactFlash
CA	CFast
MS	mSATA
HM	Half Size mSATA
HS	Half Slim
M4	M.2 2242
M6	M.2 2260
M8	M.2 2280
0V	PATA Disk 40pin Vertical
4V	PATA Disk 44pin Vertical
4L	PATA Disk 44pin Horizontal Left
7T	SATA Disk 7pin Vertical Tall
7L	SATA Disk 7pin Horizontal Left
7R	SATA Disk 7pin Horizontal Right

3. Product Series

S	Supreme Series (SLC)
R	Reliance Series (RO-MLC)
M	Momentum Series (MLC)

4. Cervoz Family Code

Bus and Internal Control for Cervoz Product Families

5. Flash Brand

M	Micron
T	Toshiba

6. Flash Capacity

A	256Mb
B	512Mb

C	1Gb
D	2Gb
E	4Gb
F	8Gb
G	16Gb
H	32Gb
I	64Gb
J	128Gb
K	256Gb
L	512Gb
M	1Tb

7. Flash Mode

Internal Control for Flash Mode

8. Module Capacity

128M	128MB
256M	256MB
512M	512MB
001G	1GB
002G	2GB
004G	4GB
008G	8GB
016G	16GB
032G	32GB
064G	64GB
128G	128GB
256G	256GB
512G	512GB

9. Operating Temperature

S	Standard Grade (0~ +70°C)
W	Wide Temperature Grade (-40 ~ +85°C)